

DC MINI-SHORTER INDUCTIVE PROXIMITY SENSOR

CHARACTERISTICS

- Stainless-Steel Cylinders in Ø6.5, Ø8, M8
- Square Brass Cubes in Q8
- PNP and NPN Version
- N.O. or N.C. Configurations
- High-speed Response
- IP67 Protection, Water-proof, Oil-proof and Dust-proof



HIGHLIGHTS

- Maximum Uptime
- Long-term Reliability
- Fully Integrated Electronics
- Standard LED Output State Indicator
- EMC Protection And CE Conformity Achieved
- Shielded Installation Protects Against Mechanical Impact Or Damage
- With Short-Circuit Protection, Overload Protection, Polarity Reversal Protection

APPLICATIONS

● Machine Tools



● Industry Equipment

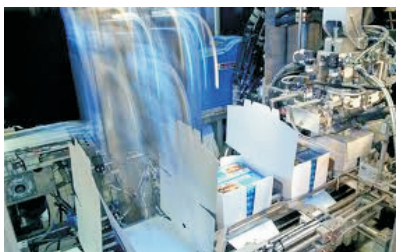

● Packing Machines

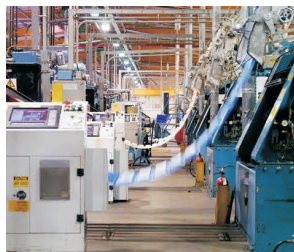



Features:

- Ø6.5mm diameter
- Sn=1/2/3mm shielded
- Stainless steel housing case
- 10-30VDC operating voltage
- Short circuit protection
- Overload protection
- Reverse-polarity protection
- NPN, PNP Output
- NO, NC Function
- Cable version
- M8 Pigtail version
- IP67 Protection

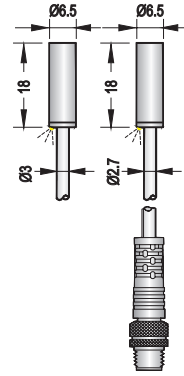

(Unit: mm)

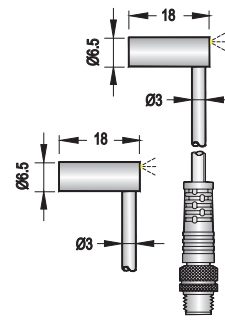

(Unit: mm)

		Shielded			Shielded		
		Standard Sn	Extended Sn	Long Sn	Standard Sn	Extended Sn	Long Sn
2m Cable	NPN-NO	L1DA6.5C01A	L1DA6.5C02A	L1DA6.5C03A	S1DA6.5C01A	S1DA6.5C02A	S1DA6.5C03A
	NPN-NC	L1DA6.5D01A	L1DA6.5D02A	L1DA6.5D03A	S1DA6.5D01A	S1DA6.5D02A	S1DA6.5D03A
	PNP-NO	L1DA6.5A01A	L1DA6.5A02A	L1DA6.5A03A	S1DA6.5A01A	S1DA6.5A02A	S1DA6.5A03A
	PNP-NC	L1DA6.5B01A	L1DA6.5B02A	L1DA6.5B03A	S1DA6.5B01A	S1DA6.5B02A	S1DA6.5B03A
	NPN-NO+NC						
	PNP-NO+NC						
M8 Pigtail	NPN-NO	L1DA6.5C01N	L1DA6.5C02N	L1DA6.5C03N	S1DA6.5C01N	S1DA6.5C02N	S1DA6.5C03N
	NPN-NC	L1DA6.5D01N	L1DA6.5D02N	L1DA6.5D03N	S1DA6.5D01N	S1DA6.5D02N	S1DA6.5D03N
	PNP-NO	L1DA6.5A01N	L1DA6.5A02N	L1DA6.5A03N	S1DA6.5A01N	S1DA6.5A02N	S1DA6.5A03N
	PNP-NC	L1DA6.5B01N	L1DA6.5B02N	L1DA6.5B03N	S1DA6.5B01N	S1DA6.5B02N	S1DA6.5B03N
	NPN-NO+NC						
	PNP-NO+NC						

General Data							
Housing size	Ø6.5mm			Ø6.5mm			
Installation type	Shielded			Shielded			
Sensing distance(Sn: mm)	1mm	2mm	3mm	1mm	2mm	3mm	
Standard sensing object	Steel 6.5x6.5x1mm	Steel 6.5x6.5x1mm	Steel 9x9x1mm	Steel 6.5x6.5x1mm	Steel 6.5x6.5x1mm	Steel 9x9x1mm	
Effective sensing distance (Sr: mm)	90 ... 110% of Sn			90 ... 110% of Sn			
Assured operating distance(Sa: mm)	0 ... 80% of Sn			0 ... 80% of Sn			
Hysteresis	<15%			<15%			
Housing material	Stainless steel			Stainless steel			
Operating voltage	10 ... 30VDC			10 ... 30VDC			
Electrical Data							
Rated operating voltage	24VDC			24VDC			
Repeated accuracy	±10%			±10%			
Ripple	<10%			<10%			
No load current	10mA			10mA			
Max. Load current	200mA			200mA			
Leakage current	<0.01mA			<0.01mA			
Voltage drop	<1.5VDC	<1.5VDC	<1.5VDC	<1.5VDC	<1.5VDC	<1.5VDC	
Switching frequency	2000Hz	2000Hz	1000Hz	2000Hz	2000Hz	1000Hz	
Response time	0.1ms/0.1ms	0.1ms/0.1ms	0.2ms/0.2ms	0.1ms/0.1ms	0.1ms/0.1ms	0.2ms/0.2ms	
Rated insulation voltage	75VDC			75VDC			
Operating temperature	-25°C ... +70°C			-25°C ... +70°C			
Storage temperature	-40°C ... +80°C			-40°C ... +80°C			
Temperature drift	<10%			<10%			
Power indicator	No			No			
Function indicator	Yellow LED			Yellow LED			
Reverse polarity protection	Yes			Yes			
Short-circuit protection	Yes			Yes			
Overload trip point	220mA			220mA			
Correction factors	Fe37 steel=1/stainless steel approx. 0.85/brass approx. 0.5/ Al. Approx. 0.45/copper approx. 0.4			Fe37 steel=1/stainless steel approx. 0.85/brass approx. 0.5/ Al. Approx. 0.45/copper approx. 0.4			
Mechanical Data							
Sensing surface material	POM			POM			
Protection	IP67			IP67			
Shock rating	Shock, half-sinus, 30gn, 11ms			Shock, half-sinus, 30gn, 11ms			
Vibration rating	55Hz, 1mm ampl., 3x30min.			55Hz, 1mm ampl., 3x30min.			
EMC	IEC 60947-5-2			IEC 60947-5-2			
Accessory	/			/			
Connection	2m PVC cable (Ø3 3x0.15mm ²)/300mm Pigtail(3Pin M8 connector)			2m PVC cable (Ø3 3x0.15mm ²)/300mm Pigtail(3Pin M8 connector)			
Weight	Approx. 25g			Approx. 25g			

Features: <ul style="list-style-type: none"> • Ø6.5mm diameter • Sn=1/2/3mm shielded • Stainless steel housing case • 10-30VDC operating voltage • Short circuit protection • Overload protection • Reverse-polarity protection • NPN, PNP Output • NO, NC Function • M8 connector version • IP67 Protection 		<p>(Unit: mm)</p>					
		Standard Sn	Extended Sn	Long Sn			
2m Cable	NPN-NO						
	NPN-NC						
	PNP-NO						
	PNP-NC						
	NPN-NO+NC						
M8 Connector	NPN-NO	L1DA6.5C01F	L1DA6.5C02F	L1DA6.5C03F			
	NPN-NC	L1DA6.5D01F	L1DA6.5D02F	L1DA6.5D03F			
	PNP-NO	L1DA6.5A01F	L1DA6.5A02F	L1DA6.5A03F			
	PNP-NC	L1DA6.5B01F	L1DA6.5B02F	L1DA6.5B03F			
	NPN-NO+NC						
General Data							
Housing size		Ø6.5mm					
Installation type		Shielded					
Sensing distance(Sn: mm)		1mm	2mm	3mm			
Standard sensing object		Steel 6.5x6.5x1mm	Steel 6.5x6.5x1mm	Steel 9x9x1mm			
Effective sensing distance (Sr: mm)		90 ... 110% of Sn					
Assured operating distance(Sa: mm)		0 ... 80% of Sn					
Hysteresis		<15%					
Housing material		Stainless steel					
Operating voltage		10 ... 30VDC					
Electrical Data							
Rated operating voltage		24VDC					
Repeated accuracy		±10%					
Ripple		<10%					
No load current		10mA					
Max. Load current		200mA					
Leakage current		<0.01mA					
Voltage drop		<1.5VDC	<1.5VDC	<1.5VDC			
Switching frequency		2000Hz	2000Hz	1000Hz			
Response time		0.1ms/0.1ms	0.1ms/0.1ms	0.2ms/0.2ms			
Rated insulation voltage		75VDC					
Operating temperature		-25°C ... +70°C					
Storage temperature		-40°C ... +80°C					
Temperature drift		<10%					
Power indicator		No					
Function indicator		Yellow LED					
Reverse polarity protection		Yes					
Short-circuit protection		Yes					
Overload trip point		220mA					
Correction factors		Fe37 steel=1/stainless steel approx. 0.85/brass approx. 0.5/ Al. Approx. 0.45/copper approx. 0.4					
Mechanical Data							
Sensing surface material		POM					
Protection		IP67					
Shock rating		Shock, half-sinus, 30gn, 11ms					
Vibration rating		55Hz, 1mm ampl., 3x30min.					
EMC		IEC 60947-5-2					
Accessory		/					
Connection		Pico-Style(3Pin M8 connector)					
Weight		Approx. 4g					



Features:

- M8mm diameter
- Sn=1/2/3mm shielded
- Stainless steel housing case
- 10-30VDC operating voltage
- Short circuit protection
- Overload protection
- Reverse-polarity protection
- NPN, PNP Output
- NO, NC Function
- Cable version
- M8 Pigtail version
- M8 Connector version
- IP67 Protection

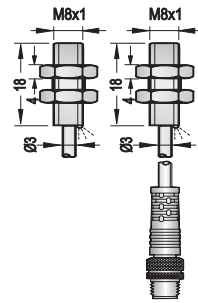

(Unit: mm)

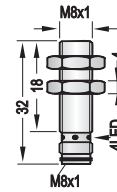

(Unit: mm)

		Shielded			Shielded		
		Standard Sn	Extended Sn	Long Sn	Standard Sn	Extended Sn	Long Sn
2m Cable	NPN-NO	L1CA08C01A	L1CA08C02A	L1CA08C03A			
	NPN-NC	L1CA08D01A	L1CA08D02A	L1CA08D03A			
	PNP-NO	L1CA08A01A	L1CA08A02A	L1CA08A03A			
	PNP-NC	L1CA08B01A	L1CA08B02A	L1CA08B03A			
	NPN-NO+NC						
	PNP-NO+NC						
M8 Pigtail	NPN-NO	L1CA08C01N	L1CA08C02N	L1CA08C03N	L1CA08C01F	L1CA08C02F	L1CA08C03F
	NPN-NC	L1CA08D01N	L1CA08D02N	L1CA08D03N	L1CA08D01F	L1CA08D02F	L1CA08D03F
	PNP-NO	L1CA08A01N	L1CA08A02N	L1CA08A03N	L1CA08A01F	L1CA08A02F	L1CA08A03F
	PNP-NC	L1CA08B01N	L1CA08B02N	L1CA08B03N	L1CA08B01F	L1CA08B02F	L1CA08B03F
	NPN-NO+NC						
M8 Connector	PNP-NO+NC						

General Data						
Housing size	M8mm			M8mm		
Installation type	Shielded			Shielded		
Sensing distance(Sn: mm)	1mm	2mm	3mm	1mm	2mm	3mm
Standard sensing object	Steel 8x8x1mm	Steel 8x8x1mm	Steel 9x9x1mm	Steel 8x8x1mm	Steel 8x8x1mm	Steel 9x9x1mm
Effective sensing distance (Sr: mm)	90 ... 110% of Sn			90 ... 110% of Sn		
Assured operating distance(Sa: mm)	0 ... 80% of Sn			0 ... 80% of Sn		
Hysteresis	<15%			<15%		
Housing material	Stainless steel			Stainless steel		
Operating voltage	10 ... 30VDC			10 ... 30VDC		
Electrical Data						
Rated operating voltage	24VDC			24VDC		
Repeated accuracy	±10%			±10%		
Ripple	<10%			<10%		
No load current	10mA			10mA		
Max. Load current	200mA			200mA		
Leakage current	<0.01mA			<0.01mA		
Voltage drop	<1.5VDC	<1.5VDC	<1.5VDC	<1.5VDC	<1.5VDC	<1.5VDC
Switching frequency	2000Hz	2000Hz	1000Hz	2000Hz	2000Hz	1000Hz
Response time	0.1ms/0.1ms	0.1ms/0.1ms	0.2ms/0.2ms	0.1ms/0.1ms	0.1ms/0.1ms	0.2ms/0.2ms
Rated insulation voltage	75VDC			75VDC		
Operating temperature	-25°C ... +70°C			-25°C ... +70°C		
Storage temperature	-40°C ... +80°C			-40°C ... +80°C		
Temperature drift	<10%			<10%		
Power indicator	No			No		
Function indicator	Yellow LED			Yellow LED		
Reverse polarity protection	Yes			Yes		
Short-circuit protection	Yes			Yes		
Overload trip point	220mA			220mA		
Correction factors	Fe37 steel=1/stainless steel approx. 0.85/brass approx. 0.5/ Al. Approx. 0.45/copper approx. 0.4			Fe37 steel=1/stainless steel approx. 0.85/brass approx. 0.5/ Al. Approx. 0.45/copper approx. 0.4		
Mechanical Data						
Sensing surface material	POM			POM		
Protection	IP67			IP67		
Shock rating	Shock, half-sinus, 30gn, 11ms			Shock, half-sinus, 30gn, 11ms		
Vibration rating	55Hz, 1mm ampl., 3x30min.			55Hz, 1mm ampl., 3x30min.		
EMC	IEC 60947-5-2			IEC 60947-5-2		
Accessory	2 nuts			2 nuts		
Connection	2m PVC cable (Ø3 3x0.15mm ²)/300mm Pigtail(3Pin M8 connector)			Pico-Style(3Pin M8 connector)		
Weight	Approx. 25g			Approx. 4g		



Features:

- Ø8mm diameter
- Sn=1/2/3mm shielded
- Stainless steel housing case
- 10-30VDC operating voltage
- Short circuit protection
- Overload protection
- Reverse-polarity protection
- NPN, PNP Output
- NO, NC Function
- Cable version
- M8 Pigtail version
- M8 Connector version
- IP67 Protection

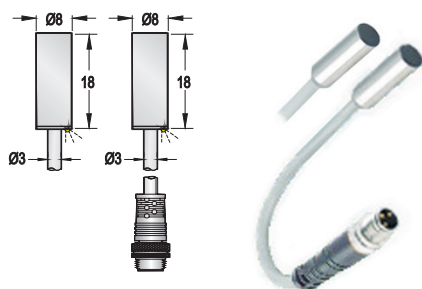

(Unit: mm)

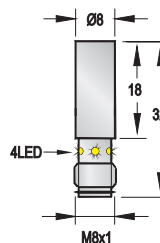

(Unit: mm)

		Shielded			Shielded		
		Standard Sn	Extended Sn	Long Sn	Standard Sn	Extended Sn	Long Sn
2m Cable	NPN-NO	L1DA08C01A	L1DA08C02A	L1DA08C03A			
	NPN-NC	L1DA08D01A	L1DA08D02A	L1DA08D03A			
	PNP-NO	L1DA08A01A	L1DA08A02A	L1DA08A03A			
	PNP-NC	L1DA08B01A	L1DA08B02A	L1DA08B03A			
	NPN-NO+NC						
	PNP-NO+NC						
M8 Pigtail	NPN-NO	L1DA08C01N	L1DA08C02N	L1DA08C03N	L1DA08C01F	L1DA08C02F	L1DA08C03F
	NPN-NC	L1DA08D01N	L1DA08D02N	L1DA08D03N	L1DA08D01F	L1DA08D02F	L1DA08D03F
	PNP-NO	L1DA08A01N	L1DA08A02N	L1DA08A03N	L1DA08A01F	L1DA08A02F	L1DA08A03F
	PNP-NC	L1DA08B01N	L1DA08B02N	L1DA08B03N	L1DA08B01F	L1DA08B02F	L1DA08B03F
	NPN-NO+NC						
	PNP-NO+NC						

General Data						
Housing size	Ø8mm			Ø8mm		
Installation type	Shielded			Shielded		
Sensing distance(Sn: mm)	1mm	2mm	3mm	1mm	2mm	3mm
Standard sensing object	Steel 8x8x1mm	Steel 8x8x1mm	Steel 9x9x1mm	Steel 8x8x1mm	Steel 8x8x1mm	Steel 9x9x1mm
Effective sensing distance (Sr: mm)	90 ... 110% of Sn			90 ... 110% of Sn		
Assured operating distance(Sa: mm)	0 ... 80% of Sn			0 ... 80% of Sn		
Hysteresis	<15%			<15%		
Housing material	Stainless steel			Stainless steel		
Operating voltage	10 ... 30VDC			10 ... 30VDC		
Electrical Data						
Rated operating voltage	24VDC			24VDC		
Repeated accuracy	±10%			±10%		
Ripple	<10%			<10%		
No load current	10mA			10mA		
Max. Load current	200mA			200mA		
Leakage current	<0.01mA			<0.01mA		
Voltage drop	<1.5VDC	<1.5VDC	<1.5VDC	<1.5VDC	<1.5VDC	<1.5VDC
Switching frequency	2000Hz	2000Hz	1000Hz	2000Hz	2000Hz	1000Hz
Response time	0.1ms/0.1ms	0.1ms/0.1ms	0.2ms/0.2ms	0.1ms/0.1ms	0.1ms/0.1ms	0.2ms/0.2ms
Rated insulation voltage	75VDC			75VDC		
Operating temperature	-25°C ... +70°C			-25°C ... +70°C		
Storage temperature	-40°C ... +80°C			-40°C ... +80°C		
Temperature drift	<10%			<10%		
Power indicator	No			No		
Function indicator	Yellow LED			Yellow LED		
Reverse polarity protection	Yes			Yes		
Short-circuit protection	Yes			Yes		
Overload trip point	220mA			220mA		
Correction factors	Fe37 steel=1/stainless steel approx. 0.85/brass approx. 0.5/ Al. Approx. 0.45/copper approx. 0.4			Fe37 steel=1/stainless steel approx. 0.85/brass approx. 0.5/ Al. Approx. 0.45/copper approx. 0.4		
Mechanical Data						
Sensing surface material	POM			POM		
Protection	IP67			IP67		
Shock rating	Shock, half-sinus, 30gn, 11ms			Shock, half-sinus, 30gn, 11ms		
Vibration rating	55Hz, 1mm ampl., 3x30min.			55Hz, 1mm ampl., 3x30min.		
EMC	IEC 60947-5-2			IEC 60947-5-2		
Accessory	/			/		
Connection	2m PVC cable (Ø3 3x0.15mm ²)/300mm Pigtail(3Pin M8 connector)			Pico-Style(3Pin M8 connector)		
Weight	Approx. 25g			Approx. 4g		



Features:

- Q8x8mm diameter
- Sn=1/2/3mm shielded
- Nickel plated brass housing case
- 10-30VDC operating voltage
- Short circuit protection
- Overload protection
- Reverse-polarity protection
- NPN, PNP Output
- NO, NC Function
- Cable version
- M8 Pigtail version
- M8 Connector version
- IP67 Protection

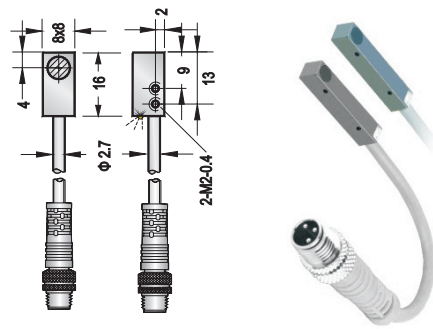

(Unit: mm)

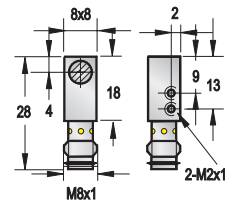

(Unit: mm)

		Shielded			Shielded		
		Standard Sn	Extended Sn	Long Sn	Standard Sn	Extended Sn	Long Sn
2m Cable	NPN-NO	LB7A-8801N-A3M2	LB7A-8802N-A3M2	LB8A-0803N-A3M2			
	NPN-NC	LB7A-8801N-B3M2	LB7A-8802N-B3M2	LB8A-0803N-B3M2			
	PNP-NO	LB7A-8801P-A3M2	LB7A-8802P-A3M2	LB8A-0803P-A3M2			
	PNP-NC	LB7A-8801P-B3M2	LB7A-8802P-B3M2	LB8A-0803P-B3M2			
	NPN-NO+NC						
	PNP-NO+NC						
M8 Pigtail	NPN-NO	LB7A-8801N-ATM3	LB7A-8802N-ATM3	LB8A-0803N-A3M2	LB8A-0801N-APM3	LB8A-0802N-APM3	LB8A-0803N-APM3
	NPN-NC	LB7A-8801N-BTM3	LB7A-8802N-BTM3	LB8A-0803N-BTM3	LB8A-0801N-BPM3	LB8A-0802N-BPM3	LB8A-0803N-BPM3
	PNP-NO	LB7A-8801P-ATM3	LB7A-8802P-ATM3	LB8A-0803P-ATM3	LB8A-0801P-APM3	LB8A-0802P-APM3	LB8A-0803P-APM3
	PNP-NC	LB7A-8801P-BTM3	LB7A-8802P-BTM3	LB8A-0803P-BTM3	LB8A-0801P-BPM3	LB8A-0802P-BPM3	LB8A-0803P-BPM3
	NPN-NO+NC						
	PNP-NO+NC						

General Data						
Housing size	Q8x8mm			Q8x8mm		
Installation type	Shielded			Shielded		
Sensing distance(Sn: mm)	1mm	2mm	3mm	1mm	2mm	3mm
Standard sensing object	Steel 8x8x1mm	Steel 8x8x1mm	Steel 9x9x1mm	Steel 8x8x1mm	Steel 8x8x1mm	Steel 9x9x1mm
Effective sensing distance (Sr: mm)	90 ... 110% of Sn			90 ... 110% of Sn		
Assured operating distance(Sa: mm)	0 ... 80% of Sn			0 ... 80% of Sn		
Hysteresis	<15%			<15%		
Housing material	Nickel plated brass			Nickel plated brass		
Operating voltage	10 ... 30VDC			10 ... 30VDC		
Electrical Data						
Rated operating voltage	24VDC			24VDC		
Repeated accuracy	±10%			±10%		
Ripple	<10%			<10%		
No load current	10mA			10mA		
Max. Load current	200mA			200mA		
Leakage current	<0.01mA			<0.01mA		
Voltage drop	<1.5VDC	<1.5VDC	<1.5VDC	<1.5VDC	<1.5VDC	<1.5VDC
Switching frequency	2000Hz	2000Hz	1000Hz	2000Hz	2000Hz	1000Hz
Response time	0.1ms/0.1ms	0.1ms/0.1ms	0.2ms/0.2ms	0.1ms/0.1ms	0.1ms/0.1ms	0.2ms/0.2ms
Rated insulation voltage	75VDC			75VDC		
Operating temperature	-25°C ... +70°C			-25°C ... +70°C		
Storage temperature	-40°C ... +80°C			-40°C ... +80°C		
Temperature drift	<10%			<10%		
Power indicator	No			No		
Function indicator	Yellow LED			Yellow LED		
Reverse polarity protection	Yes			Yes		
Short-circuit protection	Yes			Yes		
Overload trip point	220mA			220mA		
Correction factors	Fe37 steel=1/stainless steel approx. 0.85/brass approx. 0.5/ Al. Approx. 0.45/copper approx. 0.4			Fe37 steel=1/stainless steel approx. 0.85/brass approx. 0.5/ Al. Approx. 0.45/copper approx. 0.4		
Mechanical Data						
Sensing surface material	POM			POM		
Protection	IP67			IP67		
Shock rating	Shock, half-sinus, 30gn, 11ms			Shock, half-sinus, 30gn, 11ms		
Vibration rating	55Hz, 1mm ampl., 3x30min.			55Hz, 1mm ampl., 3x30min.		
EMC	IEC 60947-5-2			IEC 60947-5-2		
Accessory	/			/		
Connection	2m PVC cable (Ø3 3x0.15mm ²)/300mm Pigtail(3Pin M8 connector)			Pico-Style(3Pin M8 connector)		
Weight	Approx. 25g/20g			Approx. 6g		



Features:

- M12mm diameter
- Sn=2/4/6mm shielded
- Nickel plated brass housing case
- 10-30VDC operating voltage
- Short circuit protection
- Overload protection
- Reverse-polarity protection
- NPN, PNP Output
- NO, NC Function
- Cable version
- M8 Pigtail version
- M12 Connector version
- IP67 Protection

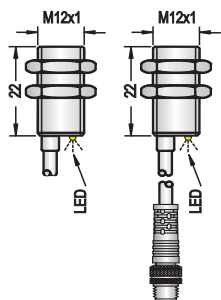

(Unit: mm)

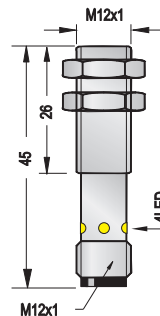

(Unit: mm)

		Shielded			Shielded		
		Standard Sn	Extended Sn	Long Sn	Standard Sn	Extended Sn	Long Sn
2m Cable	NPN-NO	L1AA12C02A	L1AA12C04A	L1AA12C06A			
	NPN-NC	L1AA12D02A	L1AA12D04A	L1AA12D06A			
	PNP-NO	L1AA12A02A	L1AA12A04A	L1AA12A06A			
	PNP-NC	L1AA12B02A	L1AA12B04A	L1AA12B06A			
	NPN-NO+NC						
M8 Pigtail	NPN-NO	L1AA12C02N	L1AA12C04N	L1AA12C06N	L1AA12C02H	L1AA12C04H	L1AA12C06H
	NPN-NC	L1AA12D02N	L1AA12D04N	L1AA12D06N	L1AA12D02H	L1AA12D04H	L1AA12D06H
	PNP-NO	L1AA12A02N	L1AA12A04N	L1AA12A06N	L1AA12A02H	L1AA12A04H	L1AA12A06H
	PNP-NC	L1AA12B02N	L1AA12B04N	L1AA12B06N	L1AA12B02H	L1AA12B04H	L1AA12B06H
	NPN-NO+NC						
M12 Connector	PNP-NO+NC						

General Data						
Housing size	M12mm			M12mm		
Installation type	Shielded			Shielded		
Sensing distance(Sn: mm)	2mm	4mm	6mm	2mm	4mm	6mm
Standard sensing object	Steel 12x12x1mm	Steel 12x12x1mm	Steel 18x18x1mm	Steel 12x12x1mm	Steel 12x12x1mm	Steel 18x18x1mm
Effective sensing distance (Sr: mm)	90 ... 110% of Sn			90 ... 110% of Sn		
Assured operating distance(Sa: mm)	0 ... 80% of Sn			0 ... 80% of Sn		
Hysteresis	<15%			<15%		
Housing material	Nickel plated brass			Nickel plated brass		
Operating voltage	10 ... 30VDC			10 ... 30VDC		

Rated operating voltage	24VDC			24VDC		
Repeated accuracy	±10%			±10%		
Ripple	<10%			<10%		
No load current	10mA			10mA		
Max. Load current	200mA			200mA		
Leakage current	<0.01mA			<0.01mA		
Voltage drop	<1.5VDC	<1.5VDC	<1.5VDC	<1.5VDC	<1.5VDC	<1.5VDC
Switching frequency	2000Hz	2000Hz	1000Hz	2000Hz	2000Hz	1000Hz
Response time	0.1ms/0.1ms	0.1ms/0.1ms	0.2ms/0.2ms	0.1ms/0.1ms	0.1ms/0.1ms	0.2ms/0.2ms
Rated insulation voltage	75VDC			75VDC		
Operating temperature	-25°C ... +70°C			-25°C ... +70°C		
Storage temperature	-40°C ... +80°C			-40°C ... +80°C		
Temperature drift	<10%			<10%		
Power indicator	No			No		
Function indicator	Yellow LED			Yellow LED		
Reverse polarity protection	Yes			Yes		
Short-circuit protection	Yes			Yes		
Overload trip point	220mA			220mA		
Correction factors	Fe37 steel=1/stainless steel approx. 0.85/brass approx. 0.5/ Al. Approx. 0.45/copper approx. 0.4			Fe37 steel=1/stainless steel approx. 0.85/brass approx. 0.5/ Al. Approx. 0.45/copper approx. 0.4		

Mechanical Data						
Sensing surface material	PBT			PBT		
Protection	IP67			IP67		
Shock rating	Shock, half-sinus, 30gn, 11ms			Shock, half-sinus, 30gn, 11ms		
Vibration rating	55Hz, 1mm ampl., 3x30min.			55Hz, 1mm ampl., 3x30min.		
EMC	IEC 60947-5-2			IEC 60947-5-2		
Accessory	2 nuts			2 nuts		
Connection	2m PVC cable (Ø4 3x0.34mm ²)/300mm Pigtail(3Pin M8 connector)			Euro-Style(4Pin M12 connector)		
Weight	Approx. 40g/25g			Approx. 25g		